

# Water proof wall mount Bracket - INSX203

**Material:** Aluminum

**Dimensions:** 160mm x 122mm x 76mm

**Color:** White

**Type of Installation:** Wall

**Net Weight:** 0.5kg

**Load Bearing Capacity:** 1kg

**Work with:** INSX152



## Dimensions (mm)

## Applications

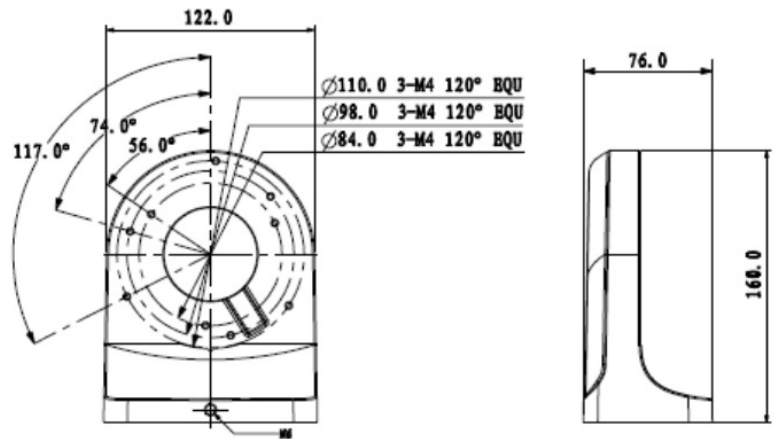
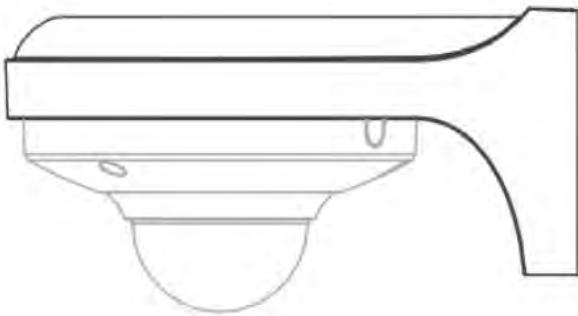

## Work with:



INSX152